

M8 male 0° / M8 female 90°

PVC 3x0.25 gy UL/CSA 5m

Male straight – female 90°

M8 – M8, 3-pole

Art-No. 7005 - M8 Lite - (plastic hexagonal screw) on request

Further cable lengths on request.

Plastic housings with good resistance against chemicals and oils.

The resistance to aggressive media should be individually tested for your application. Further details on request.

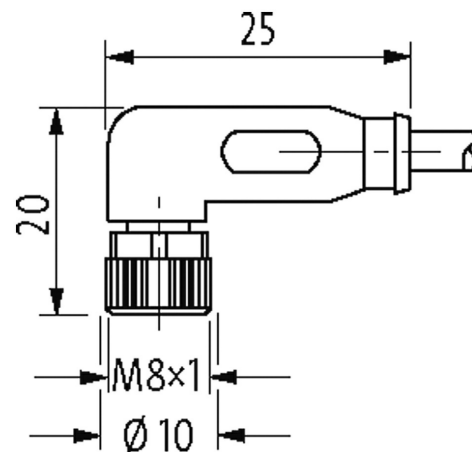
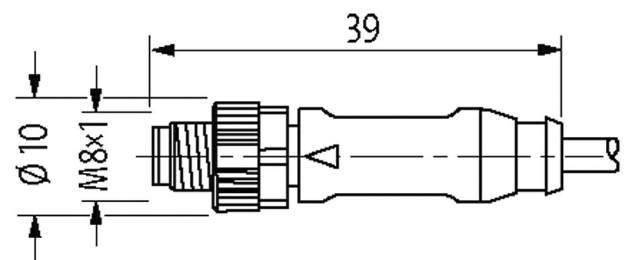
[Link to Product](#)**Illustration**

Product may differ from Image

Approvals

* only for products with UL/CSA approved cable

cCSAus

Form

Form

88021

General data

Standards	DIN EN 61076-2-104 (M8)
Mounting method	inserted, tightened
Material (contact)	Copper alloy
Material (contact surface)	Au
Material (gasket)	FKM
Pollution Degree	3
Temperature range	-25...+85 °C, depending on cable quality

Cables

Cable identification	210
Cable Type	1 (PVC)
Approval (cable)	UL (AWM-Style 2464/1731), CSA
Cable weight [g/m]	29,37
Material (wire)	Cu wire, bare
Resistor (core)	max. 79 Ω /km (20 °C)
Single wire \varnothing (core)	0.15 mm
Construction (core)	14 x 0.15 mm (multi-strand wire class 5)
Diameter (core)	3 x 0.25 mm ²
AWG	similar to AWG 24
Material (wire isolation)	PVC
Material property (wire isolation)	CFC-, cadmium-, silicone- and lead-free
Shore hardness (wire isolation)	45 \pm 5 D
Wire- \varnothing incl. isolation	1.25 mm \pm 5%
Color/numbering of wires	br, bk, bl
Stranding combination	3 wires twisted
Shield	no
Material (jacket)	PVC
Material property (jacket)	CFC-, cadmium-, silicone- and lead-free
Shore hardness (jacket)	85 \pm 5 A
Outer- \varnothing (jacket)	4.5 mm \pm 5%
Color (jacket)	gray
chemical resistance	good resistance to oil, gasoline and chemicals
thermal resistance	flame retardant UL 1581 VW1 / CSA FT1
Nominal voltage	UL 300 V AC
Test voltage	2000 V AC
Current load capacity	to DIN VDE 0298-4
Temperature range (fixed)	-30...+80 °C
Temperature range (mobile)	-5...+80 °C
Bend radius (fixed)	5 x outer \varnothing
Bend radius (moving)	10 x outer \varnothing
No./diameter of wires	3 x 0.25 mm ²
Wire isolation	PVC (br, bl, bk)
Jacket Color	gray
Material (jacket)	PVC (UL/CSA)
Outer \varnothing	4.5 mm \pm 5%
Bend radius (moving)	10 x outer \varnothing
Temperature range (fixed)	-30...+80 °C
Temperature range (mobile)	-5...+80 °C

Technical Data

Operating voltage	max. 50 V AC/60 V DC
Operating voltage (only UL listed)	30 V AC/DC
Rated surge voltage	1.5 kV
Operating current per contact	max. 4 A
No. of poles	3
Material group	IEC 60664-1, category I
LED display	no
Locking of ports	Screw thread (M8×1 mm) recommended torque 0.4 Nm, self-securing
Compression gland	M8 (SW9)
Protection	IP65, IP66K, IP67 inserted and tightened (EN 60529)
Locking material	Zinc die casting, matte nickel plated
Material	PUR
suitable for corrugated tube (internal Ø)	6.5 mm

Commercial data

country of origin	DE
customs tariff number	85444290
EAN	4048879129169
eClass	27279218
Packaging unit	1

Sketch

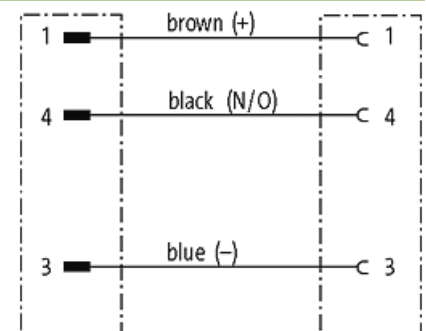

Male

Female

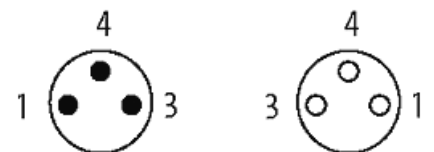

Product may differ from Image